

Halogen lamps

Double-ended flood PLUSline PRO

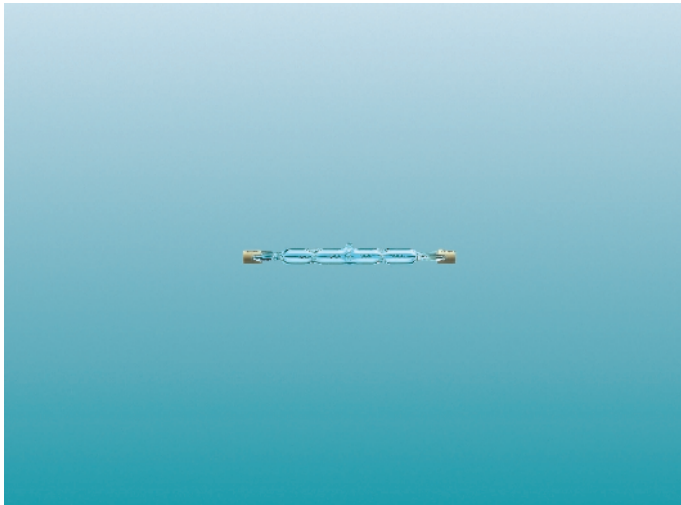

Mains-voltage, linear halogen lamps with a coiled-coil filament and a clear tubular quartz bulb. These double-ended, high-efficacy lamps are used for general lighting, task lighting and floodlighting purposes. The filament inside has reinforced filament supports for maximum safety and shock resistance. Dimples in the bulb keep the filament in position, which enables a universal burning position for types up to 500 W; above this, ± 4 degrees.

Two arc-preventing fuses for types up to 500 W provide greater security. PLUSline PRO lamps combine the benefit of 20 % more light than ordinary double-ended halogen

lamps with all the well-known benefits of halogen lighting: high luminous efficacy; crisp, white light; excellent colour rendering; constant light output during life; long life; immediate start and restart; and dimmability. Small linear types are being produced now with UV block quartz.

Note

LAMPS SHOULD BE USED IN LIGHTING EQUIPMENT WITH A COVER GLASS.

Applications

- Indoors: homes, offices, shops and museums
- Outdoors: billboards, car parks, security lighting and construction sites.

Small R7s

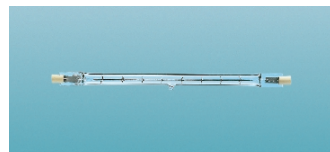
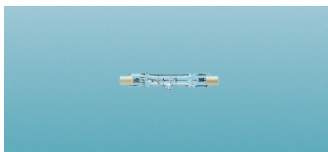

Compact R7s



Large R7s

Large FA4

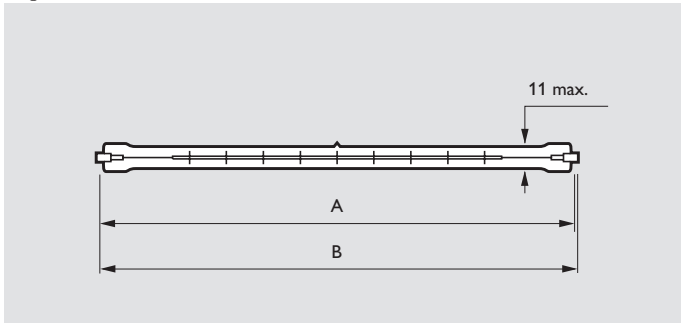

Dimensions in mm

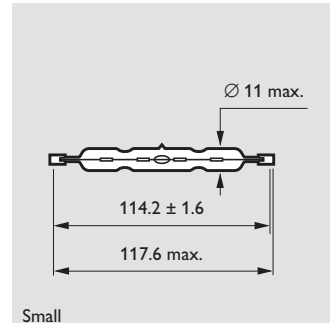

Burning positions

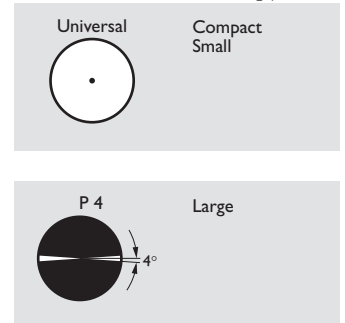

Type	A	B max.
Cap/base R7s		
Compact	74.9±.6	78.3
Large 750, 1000T3 Q/CL/P	185.7±.6	189.1
Large 1000T3(9245 157 455)	250.7±.6	254.1
Large 1500T3 Q/CL/P	250.7±.6	254.1

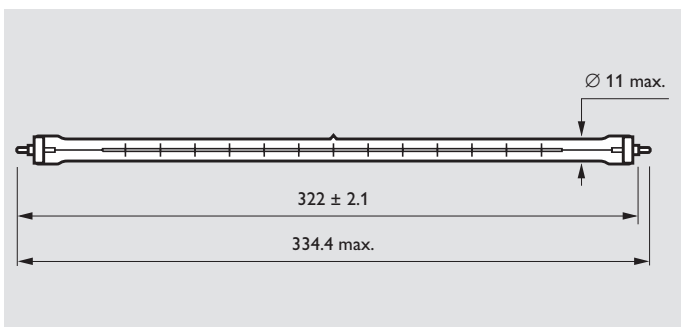

Halogen lamps

Double-ended flood PLUSline PRO

Commercial name	Type	V	W	Cap/base	Correlated colour temperature	Lumen output	Lamp current	Efficacy source	Lamp life 50%	Maximum permissible base/pinch temperature degr.C	Maximum permissible bulb temperature degr.C	EOC
COMPACT												
PLUSline PRO	60 T3 Q/CL/CP	230V	60W	R7s	2900	810	0.26	13.5	1500	350	900	494726
PLUSline PRO	100 T3 Q/CL/CP	120V	100W	R7s	2900	1600	0.83	16.0	2000	350	900	495082
PLUSline PRO	100 T3 Q/CL/CP	230V	100W	R7s	2900	1600	0.43	16.0	2000	350	900	058331
PLUSline PRO	100 T3 Q/CL/CP	240V	100W	R7s	2900	1600	0.42	16.0	2000	350	900	058270
PLUSline PRO	150 T3 Q/CL/CP	120V	150W	R7s	2900	2400	1.25	16.0	2000	350	900	495099
PLUSline PRO	150 T3 Q/CL/CP	230V	150W	R7s	2900	2400	0.65	16.0	2000	350	900	058348
PLUSline PRO	150 T3 Q/CL/CP	240V	150W	R7s	2900	2400	0.63	15.0	2000	350	900	058287
PLUSline PRO	200 T3 Q/CL/CP	230V	200W	R7s	2900	3400	0.87	17.0	2000	350	900	494290
SMALL												
PLUSline PRO	150 T3 Q/CL/P	230V	150W	R7s	2900	2250	0.65	15.0	2000	350	900	494733
PLUSline PRO	200 T3 Q/CL/P	120V	200W	R7s	2900	3520	1.67	17.6	2000	350	900	494603
PLUSline PRO	200 T3 Q/CL/P	230V	200W	R7s	2900	3520	0.87	17.6	2000	350	900	494375
PLUSline PRO	200 T3 Q/CL/P	240V	200W	R7s	2900	3520	0.83	17.6	2000	350	900	058294
PLUSline PRO	300 T3 Q/CL/P	120V	300W	R7s	2900	5200	2.50	17.0	3000	350	900	494665
PLUSline PRO	300 T3 Q/CL/P	230V	300W	R7s	2900	5600	1.30	18.7	2000	350	900	494382
PLUSline PRO	300 T3 Q/CL/P	240V	300W	R7s	2900	5600	1.25	18.7	2000	350	900	058317
PLUSline PRO	500 T3 Q/CL/P	125/130V	500W	R7s	2900	9500	3.84	19.0	3000	350	900	-
PLUSline PRO	500 T3 Q/CL/P	120V	500W	R7s	2900	9500	4.16	19.0	3000	350	900	494634
PLUSline PRO	500 T3 Q/CL/P	230V	500W	R7s	2900	9900	2.17	19.8	2000	350	900	494399
PLUSline PRO	500 T3 Q/CL/P	240V	500W	R7s	2900	9900	2.08	19.8	2000	350	900	058324
LARGE												
PLUSline PRO	750 T3 Q/CL/P	230V	750W	R7s	2900	16900	3.26	22.5	2000	350	900	494337
PLUSline PRO	750 T3 Q/CL/P	240V	750W	R7s	2900	16900	3.13	22.5	2000	350	900	055958
PLUSline PRO	1000 T3 Q/CL/P	120V	1000W	R7s	2900	24200	8.33	24.2	2000	350	900	494856
PLUSline PRO	1000 T3 Q/CL/P	230V	1000W	R7s	2900	24200	4.35	24.2	2000	350	900	494344
PLUSline PRO	1000 T3 Q/CL/P	240V	1000W	R7s	2900	21000	4.16	21.0	3000	350	900	-
PLUSline PRO	1000 T3 Q/CL/P	240V	1000W	R7s	2900	24200	4.17	24.2	2000	350	900	055972
PLUSline PRO	1500 T3 Q/CL/P	208V	1500W	R7s	2900	33000	7.21	22.0	3000	350	900	497925
PLUSline PRO	1500 T3 Q/CL/	220V	1500W	R7s	2900	33000	6.81	22.0	3000	350	900	497932
PLUSline PRO	1500 T3 Q/CL/P	230V	1500W	R7s	2900	36300	6.52	24.2	2000	350	900	494351
PLUSline PRO	1500 T3 Q/CL/P	240V	1500W	R7s	2900	36300	6.25	24.2	2000	350	900	055996
PLUSline PRO	1500 T3 Q/CL/P	277V	1500W	R7s	2900	33000	5.41	22.0	3000	350	900	497956
PLUSline PRO	2000 T3 Q/CL/P	230V	2000W	FA4	2900	48400	8.70	24.2	2000	350	900	494368
PLUSline PRO	2000 T3 Q/CL/P	240V	2000W	FA4	2900	48400	8.33	24.2	2000	350	900	056016

