

Halogen lamps

Low-voltage aluminium reflector ALUline PRO 111

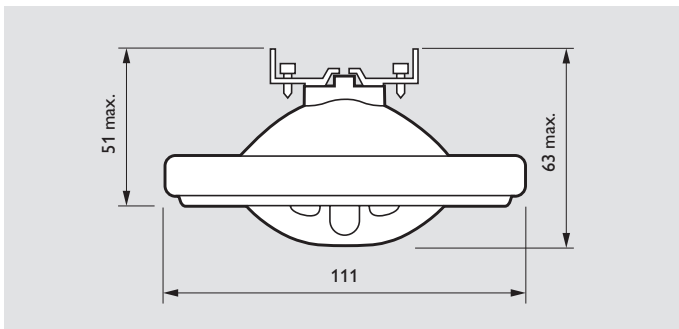

Dimensions in mm

Low-voltage halogen reflector lamp with high-purity aluminium reflector.

A metal cap shields the filament to reduce glare when looking in the direction of the light source. This cap also prevents direct light from mixing with reflected light, resulting in a smooth beam with a very sharp contrast.

The ALUline lamp can be electrically connected with a dedicated G53 socket, or using screw or tab terminals. The terminals allow direct wire connection with a mating eyelet or receptacle.

Thanks to the use of UV-block quartz and low-pressure halogen burner technology, ALUline lamps can safely be used in open fixtures.

Some lamp parts can reach a temperature of 350 °C, so precautions must be taken to prevent burning of fingers.

Applications

ALUline lamps are often applied in technically styled fixtures for accent lighting.

Typical applications include:

- shop lighting
- exhibitions and art galleries
- museum lighting

Commercial name	Type	Average lamp life	Maximum luminous intensity	Lamp power	Colour temperature	Beam angle	Net weight	EAN code
		h	cd	W	K	deg	g	87 11500
								1 unit
SPOT								
ALUline PRO	ALU111MM 50W G53 12V 8D	3000	23000	50	3000	8	85	426529
ALUline PRO	ALU111MM 75W G53 12V 8D	3000	30000	75	3000	8	85	426987
ALUline PRO	ALU111MM 100W G53 12V 8D	3000	48000	100	3000	8	85	427045
FLOOD								
ALUline PRO	ALU111MM 50W G53 12V 24D	3000	4000	50	3000	24	85	426550
ALUline PRO	ALU111MM 75W G53 12V 24D	3000	5300	75	3000	24	85	427007
ALUline PRO	ALU111MM 75W G53 12V 45D	3000	-	75	3000	45	85	-
ALUline PRO	ALU111MM 100W G53 12V 24D	3000	8500	100	3000	24	85	427069
ALUline PRO	ALU111MM 100W G53 12V 45D	3000	-	100	3000	45	85	-

Notes:

The lamp can be electrically connected through:

- a dedicated lamp socket (known as "G53")
- eyelet wire terminals matching the M4 screw terminals on the lamp
- receptacle wire terminals (e.g. AMP "Fast-on") matching the 6.3 x 0.8 mm tabs on the lamp

Halogen lamps

Low-voltage aluminium reflector ALUline PRO 111

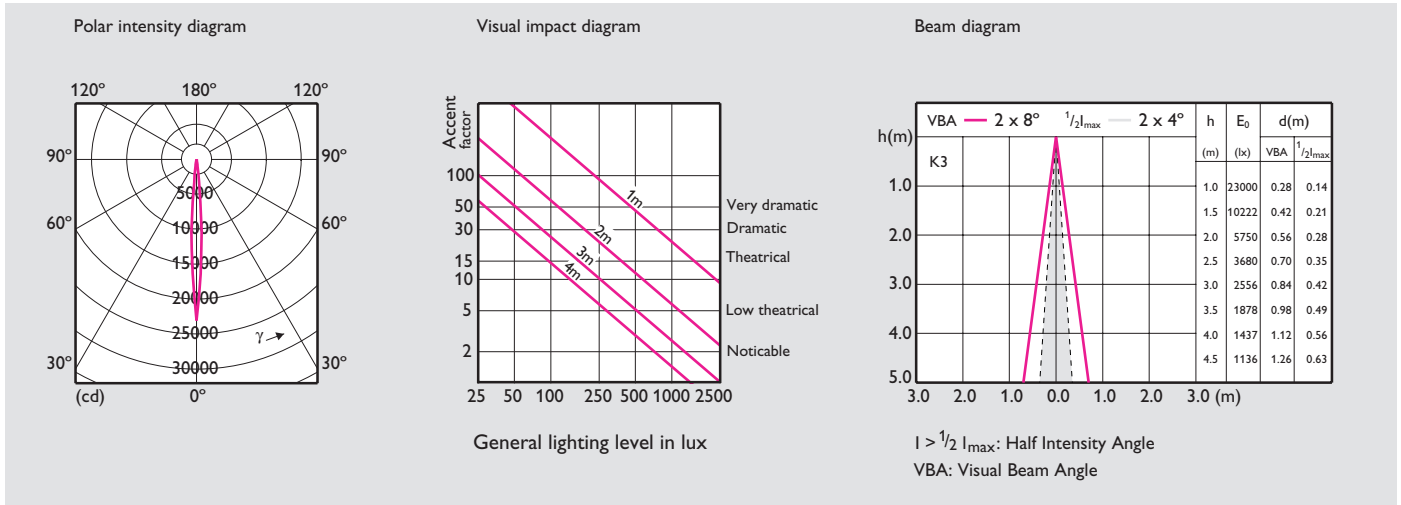

ALUline PRO 111 12V 50W 8dgr

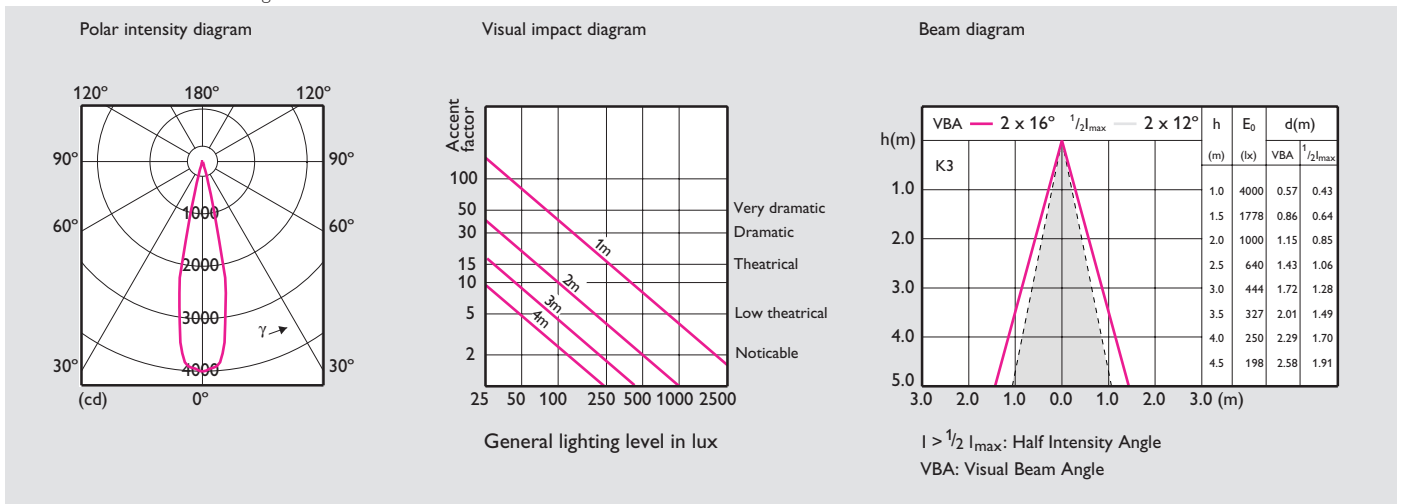

ALUline PRO 111 12V 50W 24dgr

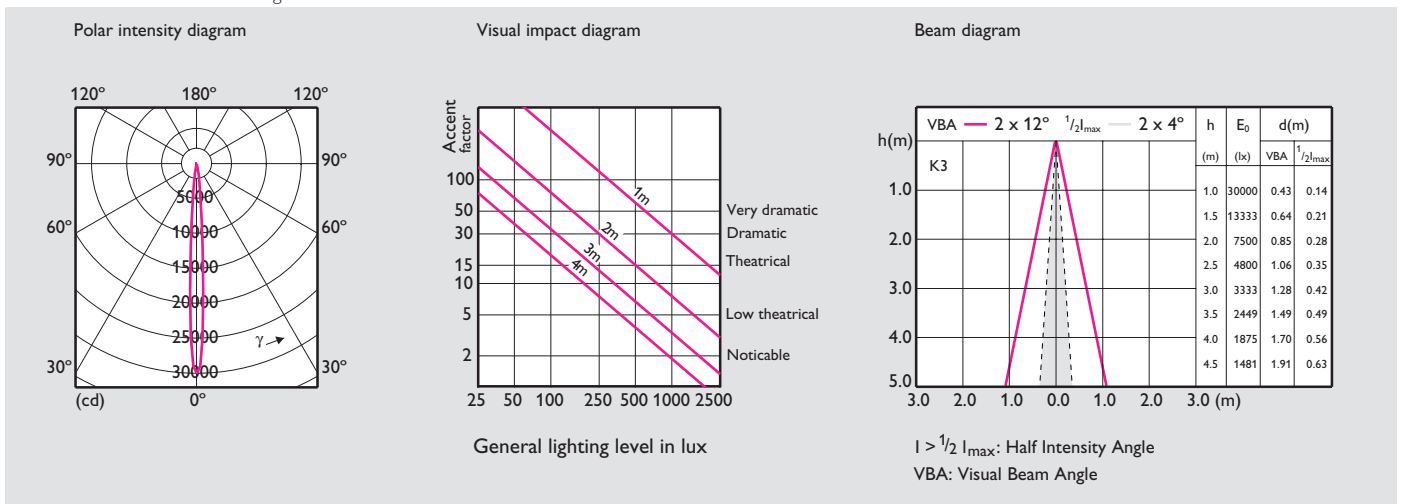

ALUline PRO 111 12V 75W 8dgr

Halogen lamps

Low-voltage aluminium reflector ALUline PRO 111

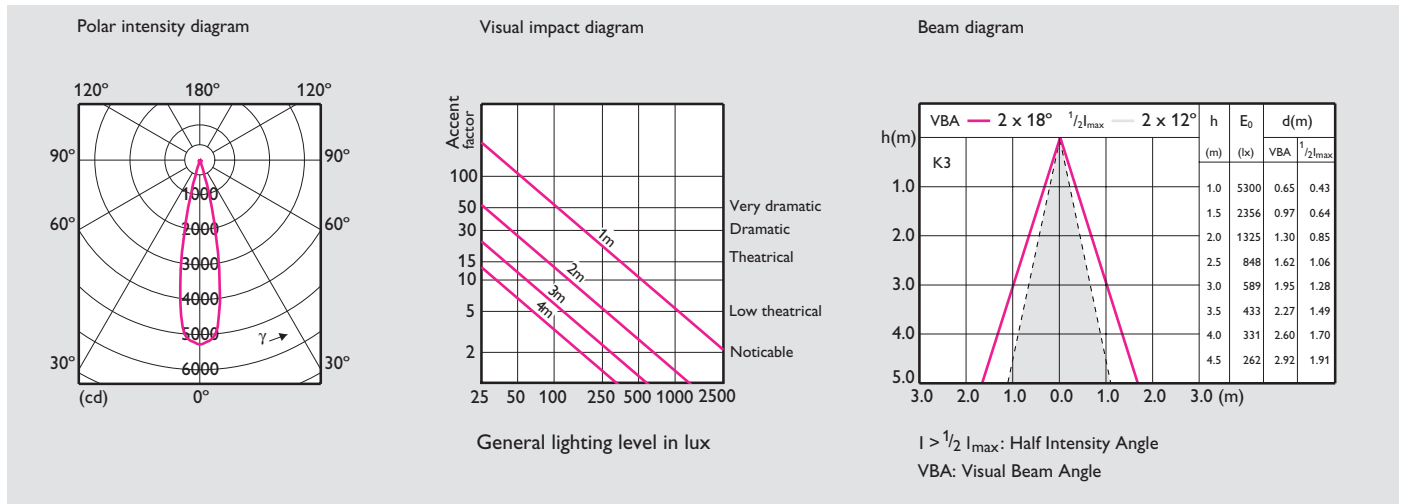

ALUline PRO 111 12V 75W 24dgr

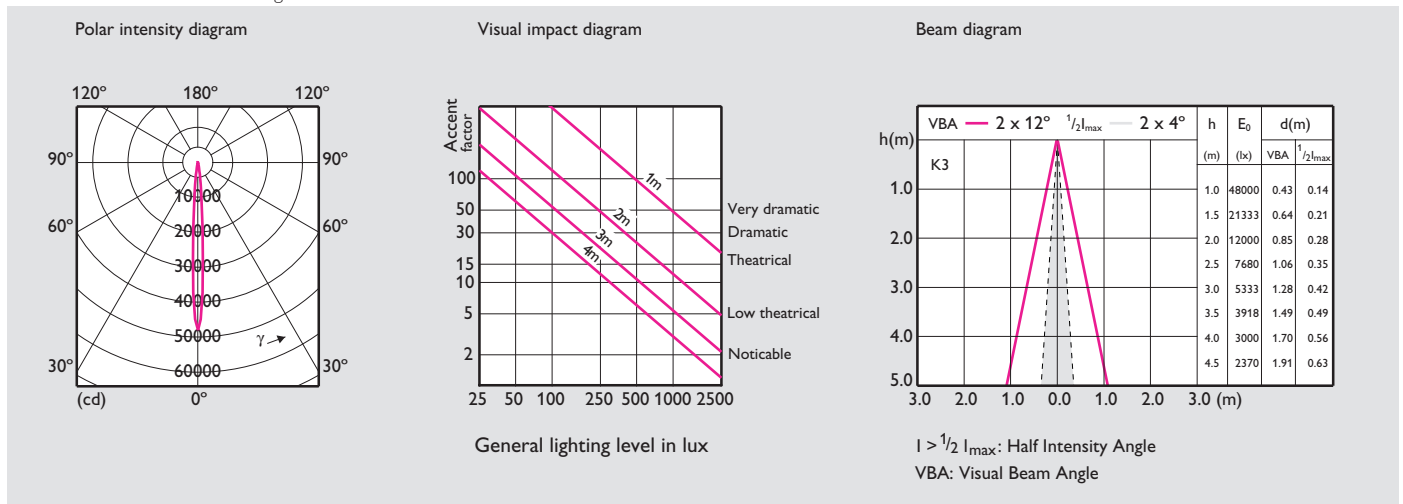

ALUline PRO 111 12V 100W 8dgr

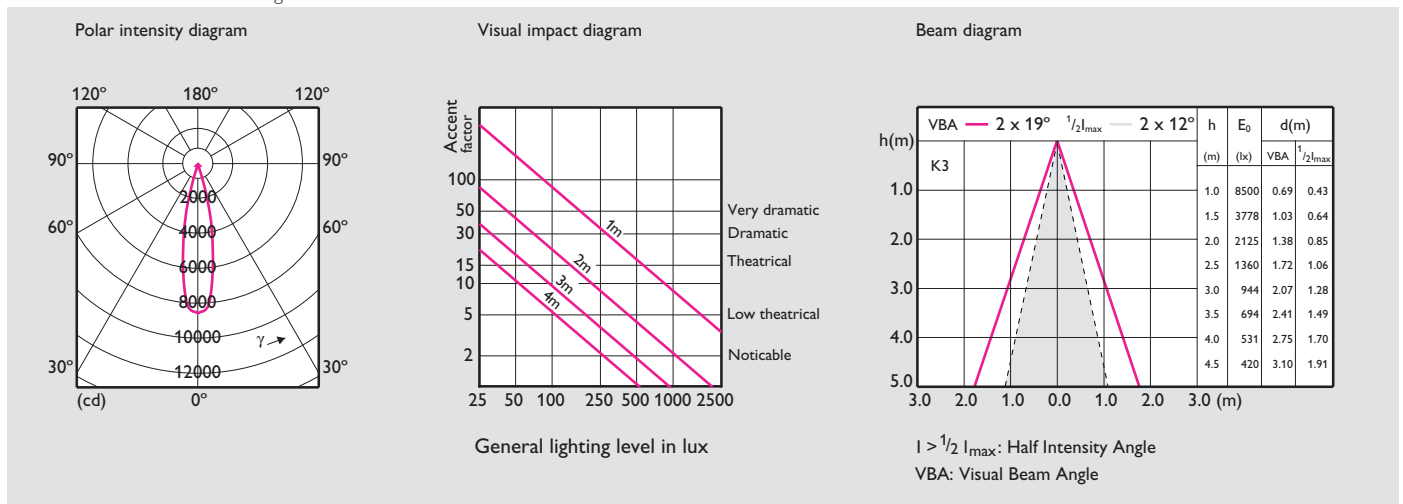

ALUline PRO 111 12V 100W 24dgr

